



FLMK70-8

2011-2024 Freightliner M2
6.7L I6 Cummins ISB Diesel (24 Valve) w/-w/o A/C

Requires 8-Groove Clutch

NOTE: Will Not Work on 2019-2024 Models w/ Air Release Fan Clutch

INSTALLATION NOTES

1. The buyer is responsible for providing trained and experienced installation decision making with technical know-how to apply professional judgment that specifically applies to each individual installation.
2. Be sure to read and understand all available information including but not limited to instructions, warnings, sales terms, and warranties for the vehicle and all system components prior to attempting installation.
3. Disconnect negative battery cable. Remove driver's side radiator support brace. Remove the OEM belt. Remove the four bolts holding the fan to the fan pulley and let fan lay inside the fan shroud. Be careful not to damage the radiator. Install new drive pulley (1) with new clutch pump drive belt (7) draped over the top of drive pulley (1) using bolts (2) going through the fan, pump drive pulley (1), then OEM fan pulley. Tighten bolts to 45 ft. lbs. Reinstall OEM belt.
4. Remove the radiator support bracket from the cylinder head and install the main bracket (3) in its place using bolts (4). Use a straight edge to align the tensioner mount parallel with drive pulley. Tighten bolts securely. Install the clutch pump onto bracket (3) using the hardware shown on the back. Align clutch with the drive pulley using a straight edge. Alignment is the installer's responsibility. Tighten all bolts securely.
5. Install the tensioner (5) onto the main bracket (3) using bolt (6). Install new pump drive belt (7). Install the radiator support brace with original bolts. Connect the battery cable. Run the engine and check for proper belt tracking and adjust if necessary.

CAUTION: Before starting the engine. Check to make certain no wires, hoses, etc. that may have been disturbed during installation do not come in contact with any hot or moving parts. Run the engine and check for proper belt tracking, adjust if necessary.

Disclaimer: (1.) Due to the custom nature and variation of all add-on systems of this type, no complete system kits are offered by the manufacturer, and any group of parts marketed as a kit is limited to only the individually defined parts in that specific kit. The system designer's rotating accessory components are not included, offered, or fully known by the manufacturer. In addition to the absence of the rotating accessory system, other potential components such as additional clamps, brackets, wear liners, hardware, or other items that may be required by the system designer must be identified and supplied by the actual system designer. (2.) Due to vehicle manufacturer's assembly tolerances, production changes, and installation variances, it is the buyer's responsibility to ensure adequate clearance for all components including space for and safe location of the fan, radiator, all lines, and wires. Check for possible movement, vibration, friction points, heat exposure and/or shifting of any and all components such as hoses, wires, and all other components including those that may otherwise be considered non-moving and/or unaffected by the installation (3.) The buyer is responsible for the entire installation of a mounting kit as the mounting kit is part of a custom process controlled by the buyer through their whole system design and directed installer as the installer evaluates, locates, routes, aligns, and tightens all components while determining if additional clamps, brackets, wear-liners, or other components may be required, beyond those included in the kit. Any additional items required, beyond those included in the kit, are to be provided at the expense of the buyer. (4.) The buyer is responsible for the development and communication of their whole system installation procedures, safety precautions, application, and use of the engine accessory mounting kit in their system, including efforts to maintain vehicle control and prevent pinch, wear, impact, and/or burn exposure on all hoses, wires, and other parts. (5.) The buyer is responsible for providing trained and experienced installation decision making with technical know-how to apply professional judgment that specifically applies to each individual installation. The buyers chosen installers must be qualified and experienced technicians that are familiar with the vehicle and accessory being mounted as well as the buyer's whole system design and installation procedures associated with the kit. (6.) The buyer is responsible for determining and achieving compliance to all regulatory issues that apply to the use of all products. (7.) The manufacturer reserves the right to make changes and/or improvements to any product at any time with or without notice.

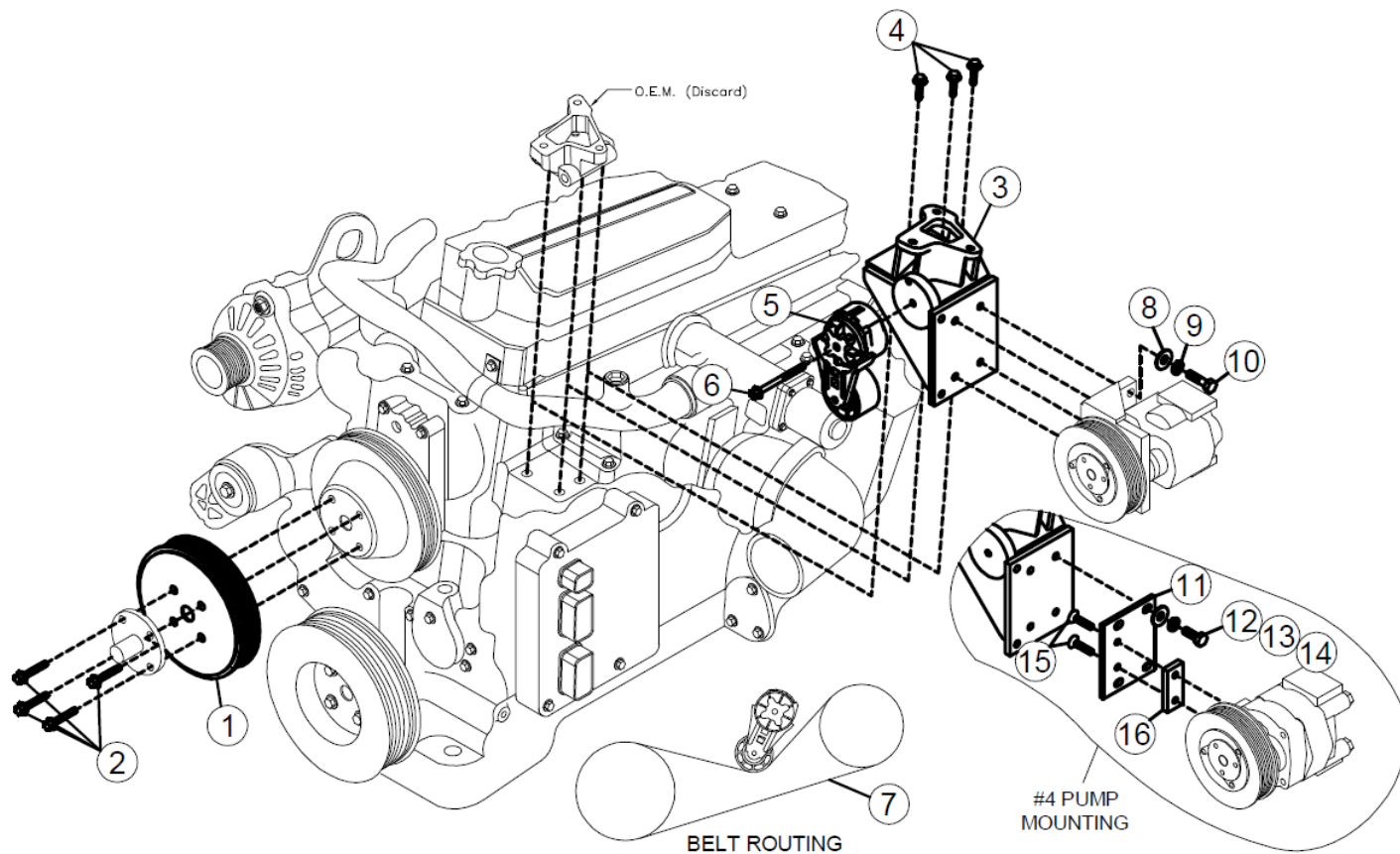

PARTS LIST							
Item	Part Number	Description	Qty.	Item	Part Number	Description	Qty.
Add-on Pulley				#2 Clutch Pump Mounting Hardware (Items 8-10)			
1	FLPC708	Add-on Pulley	1	8	1007644	3/8" Flat Washer	4
2	1006927	M10-1.5 x 30mm Flange Bolt	4	9	1010315	3/8" Lock Washer	4
Main Bracket				10	1005139	3/8"-16 x 1-1/2" NC Bolt	4
3	FLMP702-8	Main Bracket	1	#4 Clutch Pump Mounting Hardware (Items 11-16)			
Main Bracket Mounting Hardware				11	DMP554	#4 Pump Adapter Plate	1
4	1006927	M10-1.5 x 30mm Flange Bolt	3	12	1010315	3/8" Lock Washer	4
Tensioner Assembly				13	1007644	3/8" Flat Washer	4
5	89200B	Custom Tensioner	1	14	1005274	3/8"-16 x 1" NC Bolt	4
6	1003980M	M10-1.5 x 80mm Bolt MOD	1	15	1005466	1/2"-13 x 1-3/4" NC FHSCS	2
Belt (5.5" Clutch O.D.)				16	1006644	1/4" #4 Pump Spacer	1
7	5080435	Dayco 8-Groove 43.5" Belt	1				
Belt (6" Clutch O.D.)							
7	5080440	Dayco 8-Groove 44.0" Belt	1				