



SMK230SD508-8

2011-2025 Isuzu N-Series
2016-2025 Chevrolet LCF 3500-5500
5.2L I4 4HK Diesel w/-w/o A/C

Requires 8-Groove, 119mm Diameter Clutch
For use with TM13 TM15 or TM16 Ear Mount Compressor

INSTALLATION NOTES

1. The buyer is responsible for providing trained and experienced installation decision making with technical know-how to apply professional judgment that specifically applies to each individual installation.
2. Be sure to read and understand all available information including but not limited to instructions, warnings, sales terms, and warranties for the vehicle and all system components prior to attempting installation.
3. Disconnect the negative battery cable. Remove the three bolts holding the fan shroud to the engine braces. Remove the four nuts from the fan clutch and remove the fan and fan clutch assembly from the engine. Loosen the alternator belt and A/C belt if equipped. Remove alternator. Remove the fan clutch mounting plate from the water pump. Do not remove the pulley.
4. Remove the four bolts holding the crank pulley on the crankshaft. (It may be necessary to use an impact to remove the bolts). Clean any dirt or rust from the inside of the OEM pulley. Install the drive pulley (1) using four 16mm bolts (2) and lock washers (3). Tighten securely. Install the aluminum fan spacer (4) and the OEM fan clutch adapter onto the water pump using bolts (5) and lock washers (6).
5. Before the main bracket (7) can be installed a boss on the front of the engine block (approx. 1") must be removed. This can be done using a hacksaw etc. (See illustration)
6. Remove the lower alternator bracket. Remove the front two motor mount bolts. Install the main bracket (7) and spacer (8) onto the engine block at that location using bolts (9) and lock washers (11). Install new lower alternator bracket (12) using two OEM bolts at the top and bolts (10) with lock washers (11) at the bottom. Install the alternator on the new bracket (12) using the OEM bolt and nut. Install the aux. A/C compressor onto the bracket (7) using bolts (15,16), nuts (17) and slide bushings (18). Check alignment with drive pulley and install shims included with hardware only if necessary. Install the tensioner (13) with bolt (14). Install the OEM belt(s). Install the pump belt (23).
7. Install the fan onto the water pump with the four OEM nuts. Using the 1/2 spacers (21), move the fan shroud ahead and hold in place with bolts (19) and flat washers (20).

NOTE: The fan shroud brace on the lower passenger side will need to be removed and the nylon strap (22) is used to hold it in place. Connect the negative battery cable. Check for clearance on all hoses, wires, etc.

CAUTION: Before starting the engine, check to make certain no wires, hoses, etc. that may have been disturbed during installation do not come in contact with any hot or moving parts. Run the engine and check for proper belt tracking, adjust if necessary.

Disclaimer: (1.) Due to the custom nature and variation of all add-on systems of this type, no complete system kits are offered by the manufacturer, and any group of parts marketed as a kit is limited to only the individually defined parts in that specific kit. The system designer's rotating accessory components are not included, offered, or fully known by the manufacturer. In addition to the absence of the rotating accessory system, other potential components such as additional clamps, brackets, wear liners, hardware, or other items that may be required by the system designer must be identified and supplied by the actual system designer. (2.) Due to vehicle manufacturer's assembly tolerances, production changes, and installation variances, it is the buyer's responsibility to ensure adequate clearance for all components including space for and safe location of the fan, radiator, all lines, and wires. Check for possible movement, vibration, friction points, heat exposure and/or shifting of any and all components such as hoses, wires, and all other components including those that may otherwise be considered non-moving and/or unaffected by the installation (3.) The buyer is responsible for the entire installation of a mounting kit as the mounting kit is part of a custom process controlled by the buyer through their whole system design and directed installer as the installer evaluates, locates, routes, aligns, and tightens all components while determining if additional clamps, brackets, wear-liners, or other components may be required, beyond those included in the kit. Any additional items required, beyond those included in the kit, are to be provided at the expense of the buyer. (4.) The buyer is responsible for the development and communication of their whole system installation procedures, safety precautions, application, and use of the engine accessory mounting kit in their system, including efforts to maintain vehicle control and prevent pinch, wear, impact, and/or burn exposure on all hoses, wires, and other parts. (5.) The buyer is responsible for providing trained and experienced installation decision making with technical know-how to apply professional judgment that specifically applies to each individual installation. The buyers chosen installers must be qualified and experienced technicians that are familiar with the vehicle and accessory being mounted as well as the buyer's whole system design and installation procedures associated with the kit. (6.) The buyer is responsible for determining and achieving compliance to all regulatory issues that apply to the use of all products. (7.) The manufacturer reserves the right to make changes and/or improvements to any product at any time with or without notice.

Requires 8-Groove, 119mm Diameter Clutch
 For use with TM13 TM15 or TM16 Ear Mount Compressor

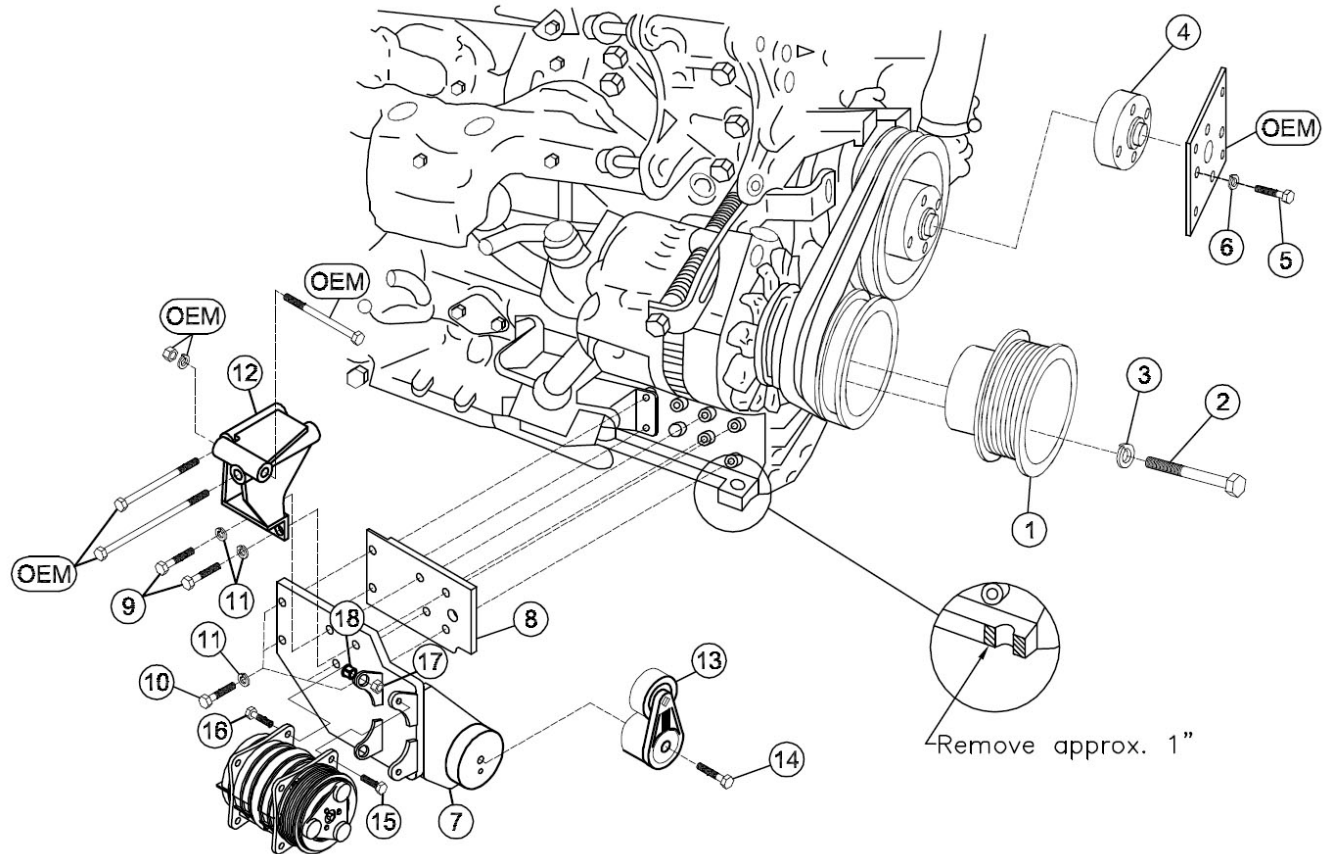

PARTS LIST

- | | |
|--------------------------|----------------------------------|
| 1. SPC 2308 (1) | 13. 89231TIPCS (1) |
| 2. 16mm x 100 mm 1.5 (4) | 14. 10mm x 55mm (1) |
| 3. 16mm LW (4) | 15. 10mm x 30mm Flange (2) |
| 4. FSO 4.7 (1) | 16. 10mm x 40mm Flange (2) |
| 5. 8mm x 35mm 10.9 (4) | 17. 10mm Flange Nut (2) |
| 6. 8mm LW (4) | 18. 1255-0090 (2) |
| 7. SMP 230SD508-8 (1) | 19. 8mm x 45mm (2) (Not Shown) |
| 8. SPS 230 (1) | 20. 8mm FW (2) (Not Shown) |
| 9. 10mm x 50mm 10.9 (2) | 21. SP64-0.500 (2) (Not Shown) |
| 10. 10mm x 40mm 10.9 (4) | 22. Nylon Strap (1) (Not Shown) |
| 11. 10mm LW (6) | 23. Belt 5080400 (1) (Not Shown) |
| 12. SMB2301 (1) | |